

一般男子単 (MS) - 1

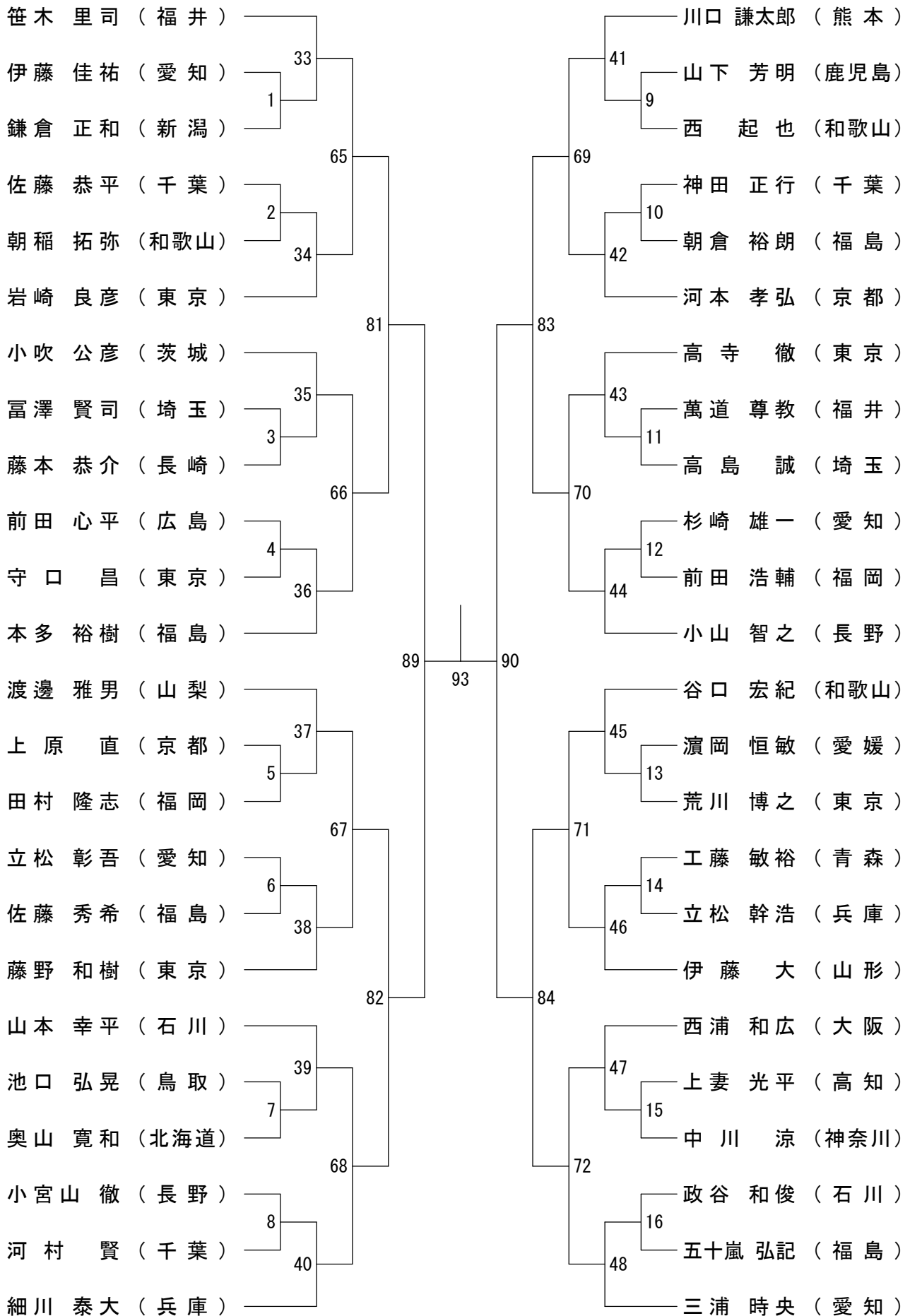

一般男子単 (MS) - 2

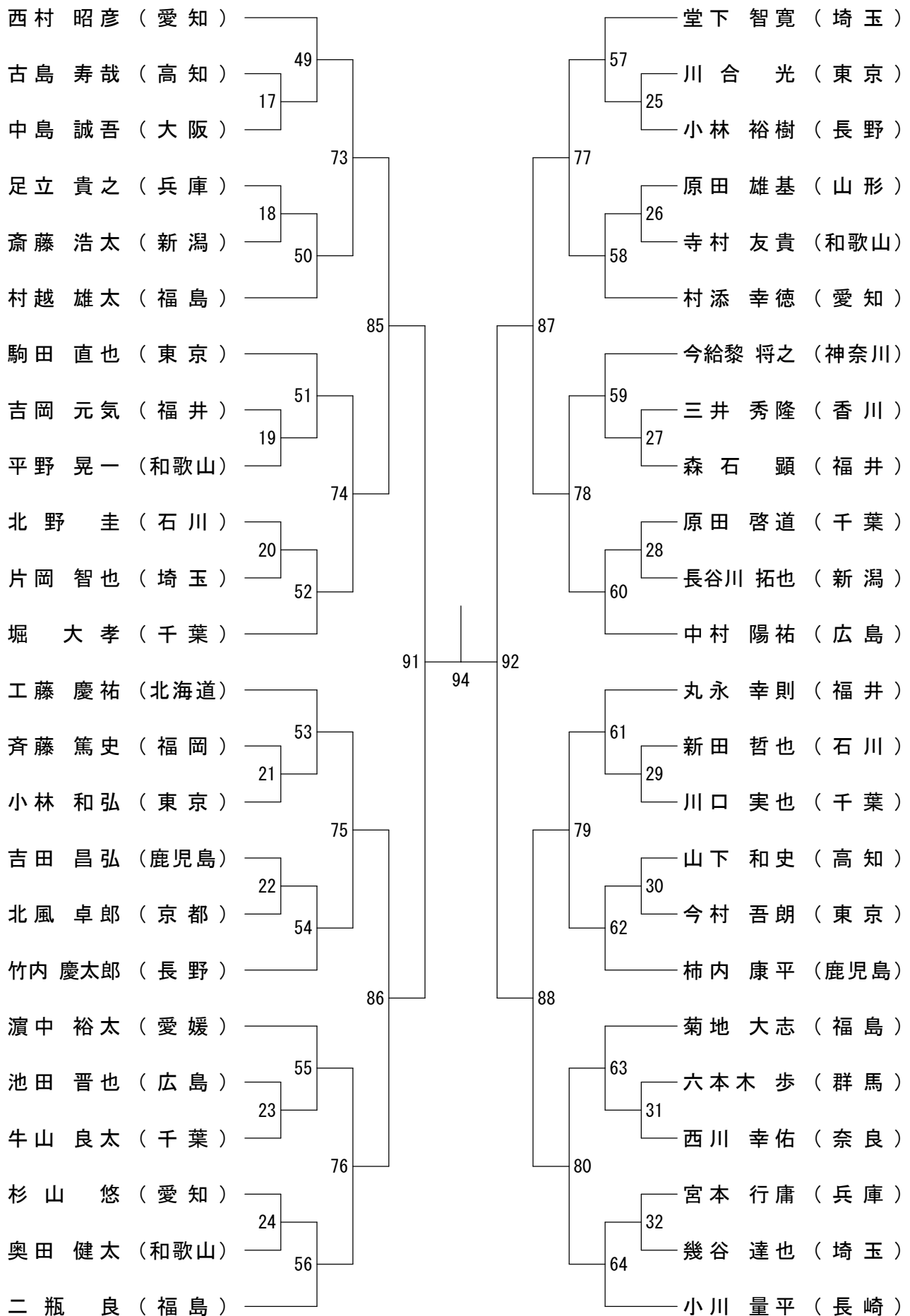

一般男子複 (MD) - 1

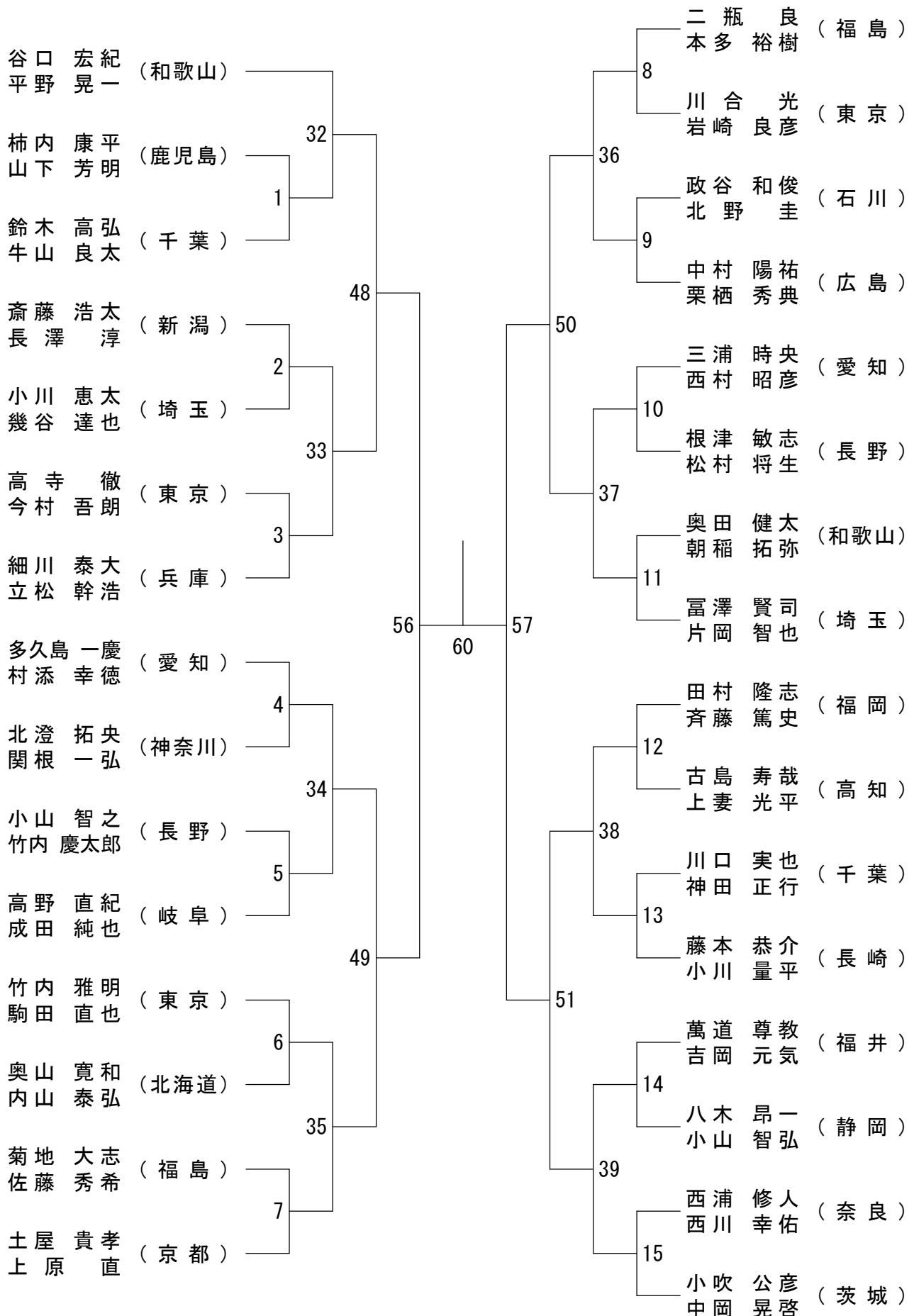

一般男子複 (MD) - 2

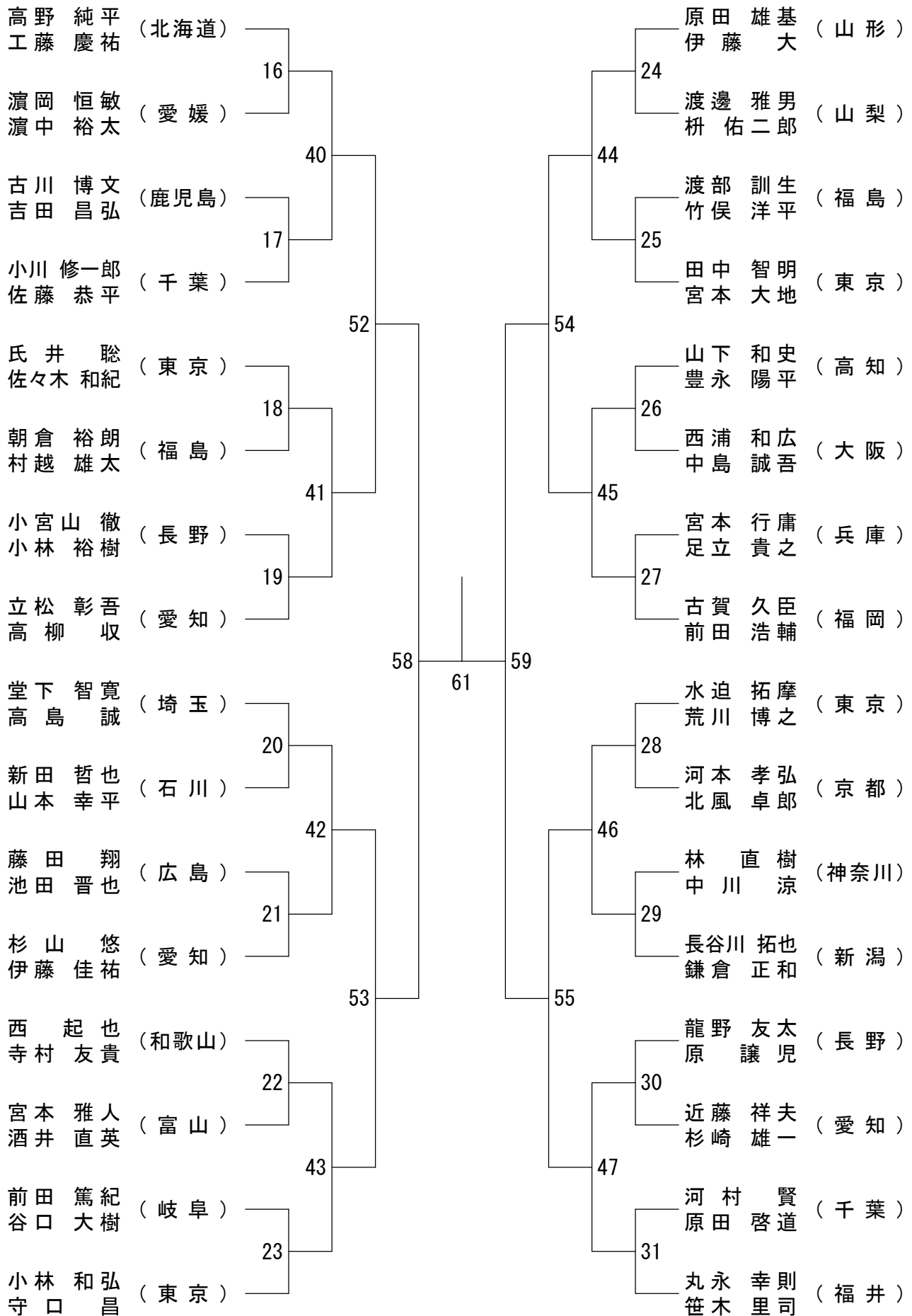

一般女子単 (WS)

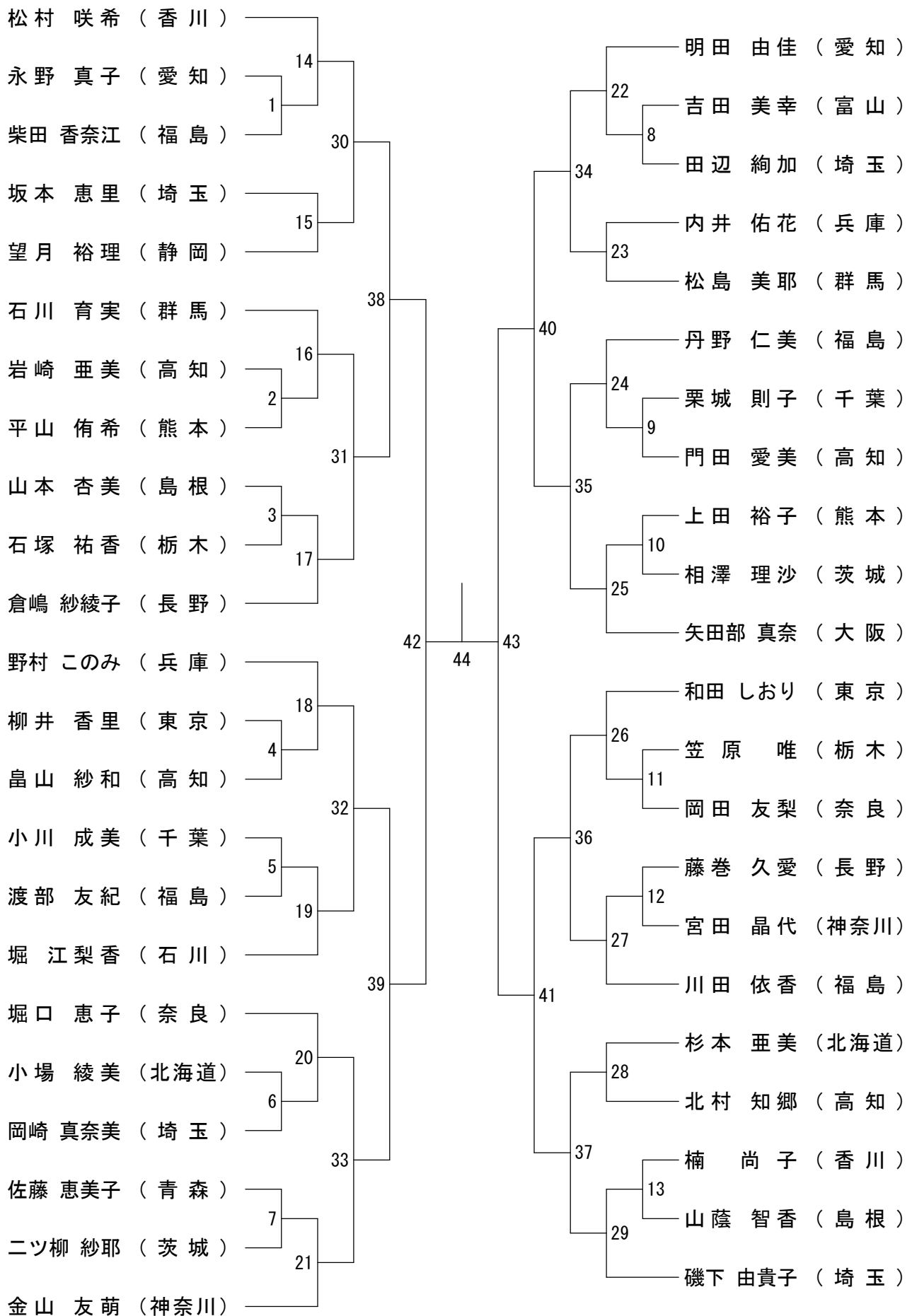

一般女子複 (WD)

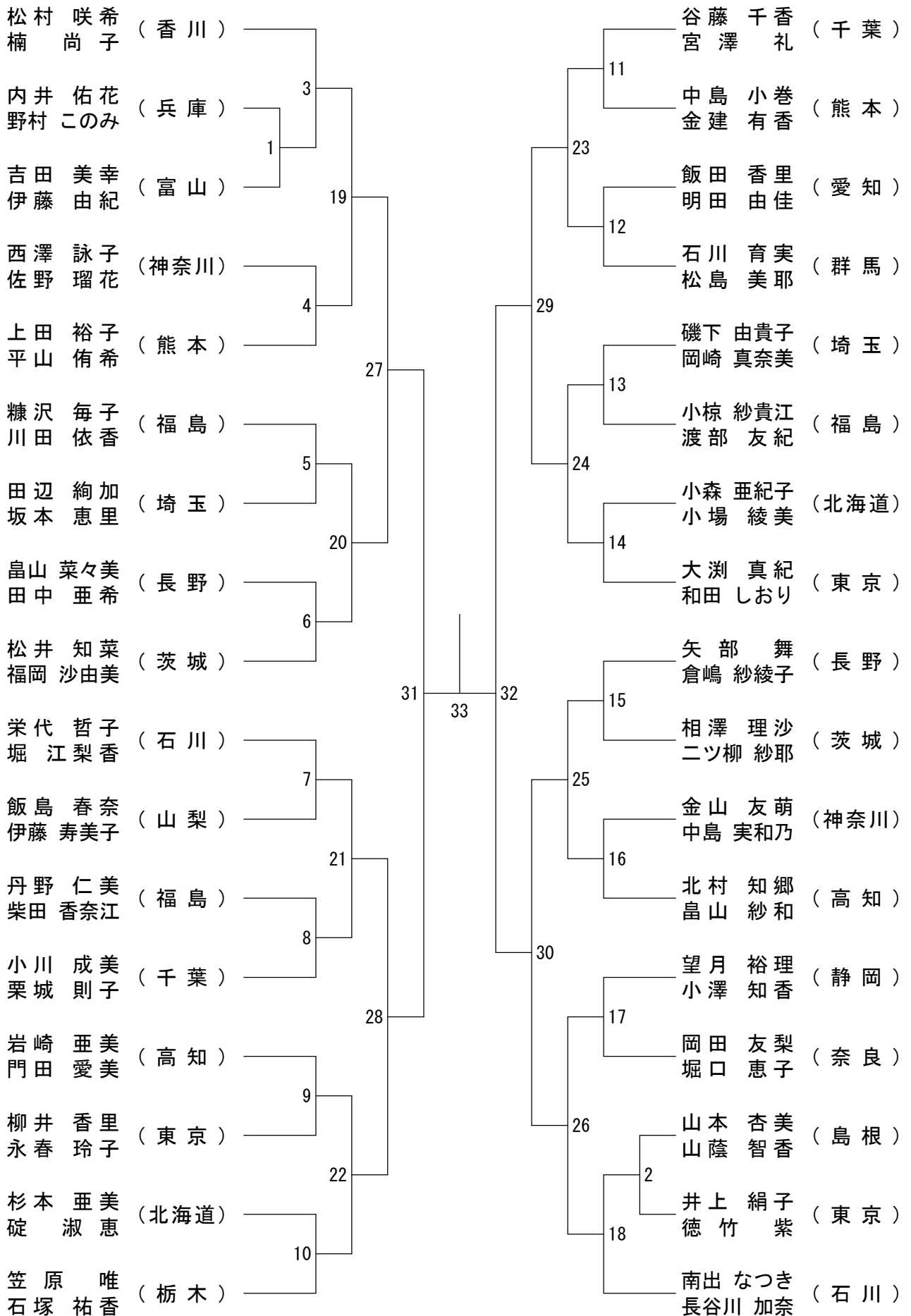

男子30歳以上単 (30MS)

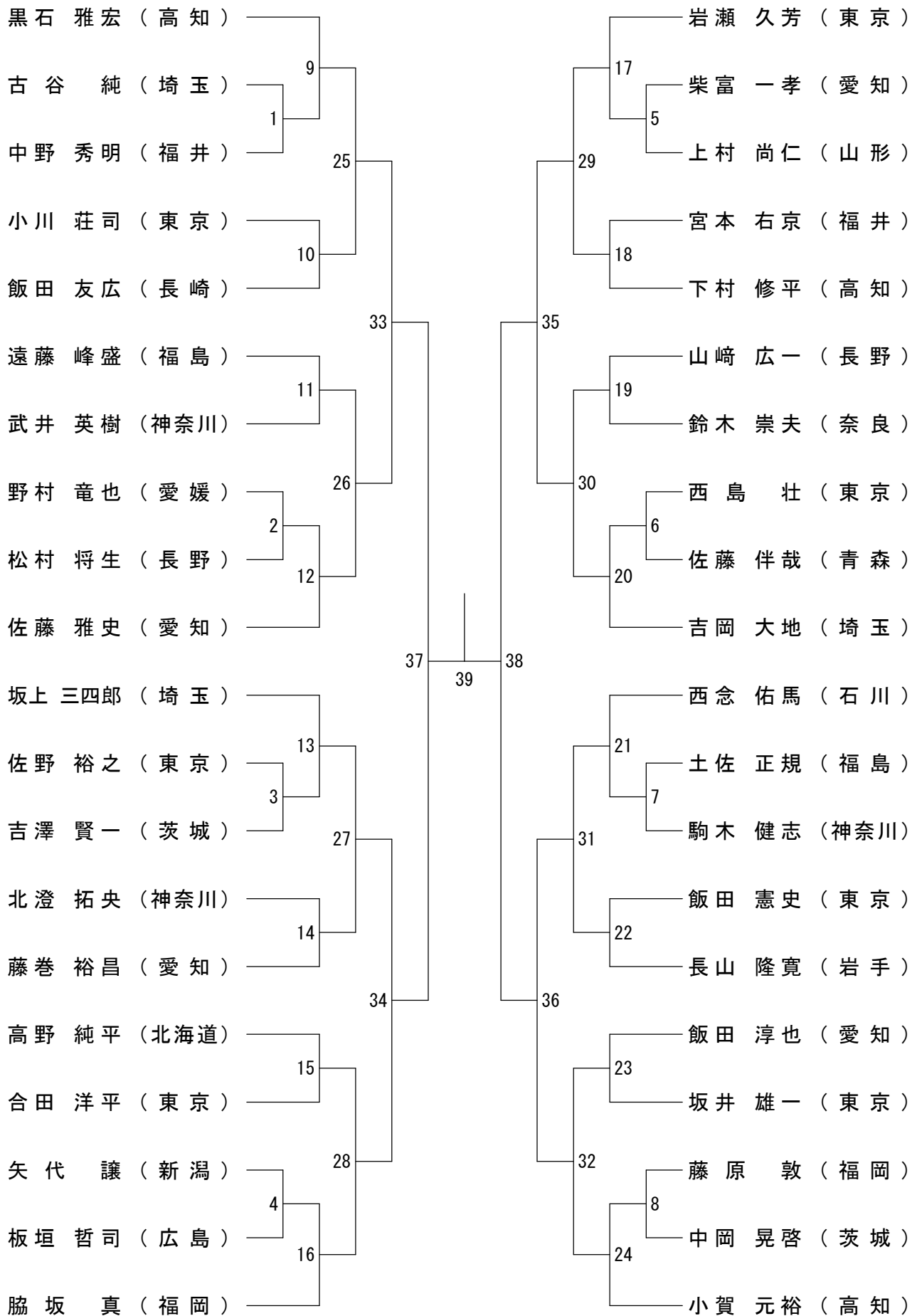

男子40歳以上単 (40MS)

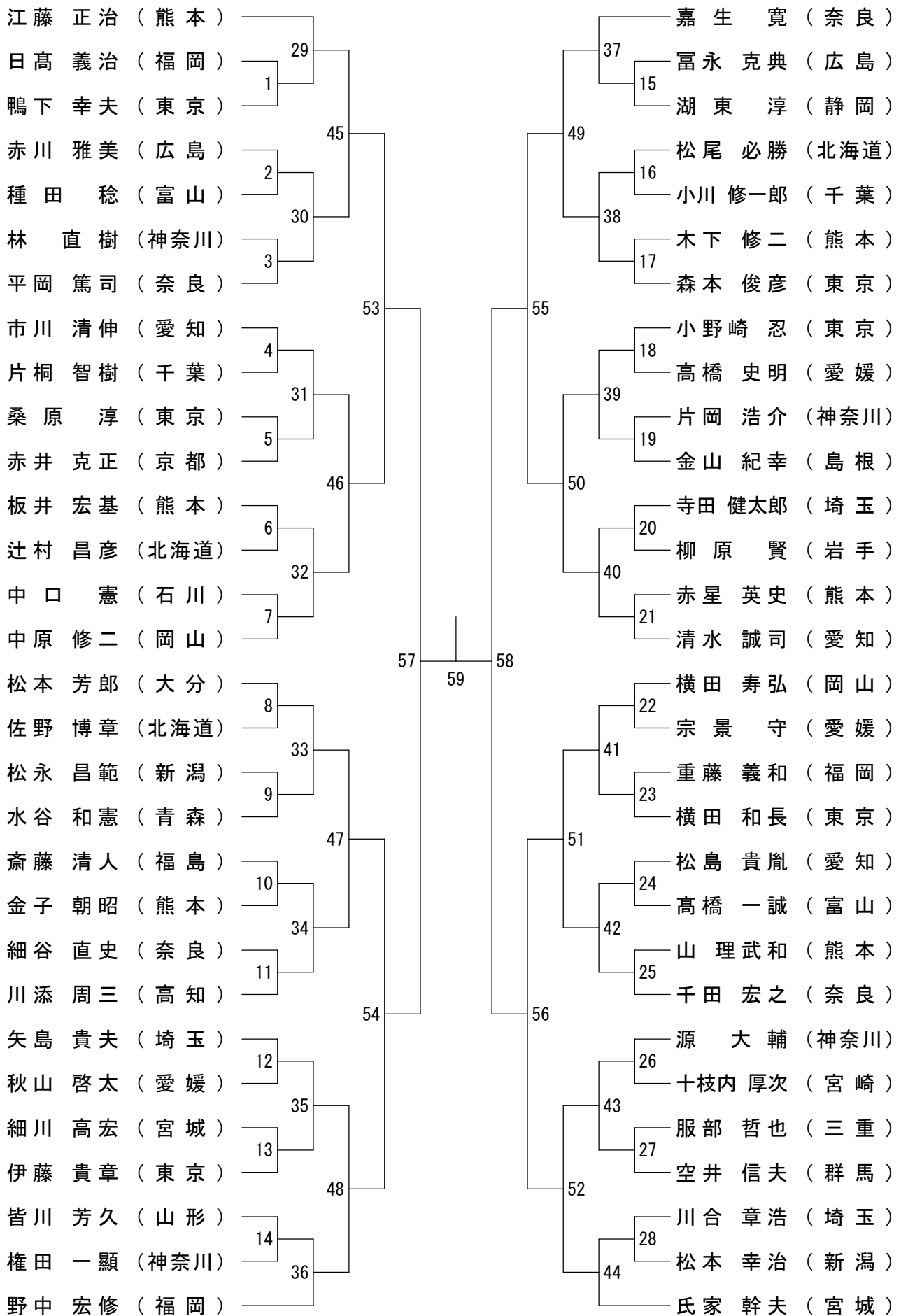



男子50歳以上単 (50MS)

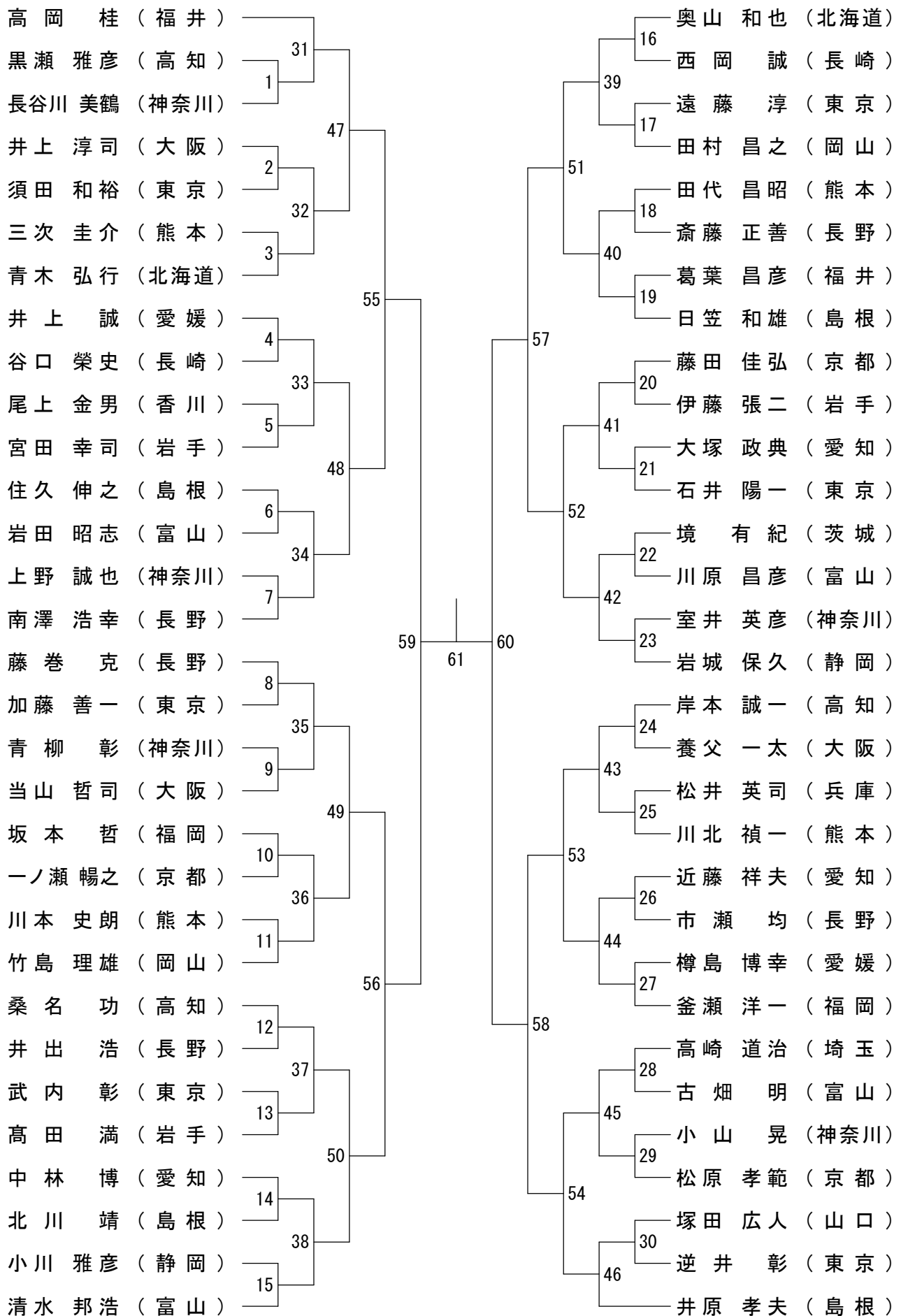

男子60歳以上単 (60MS)

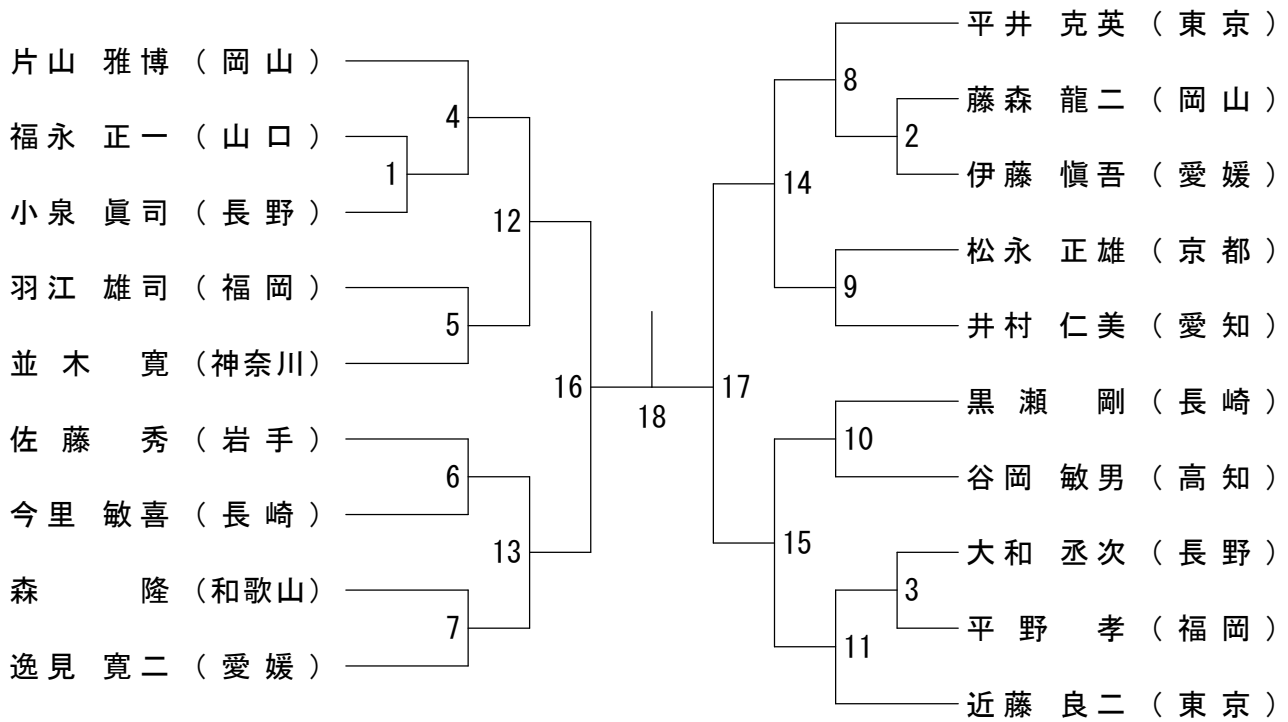

男子65歳以上単 (65MS)

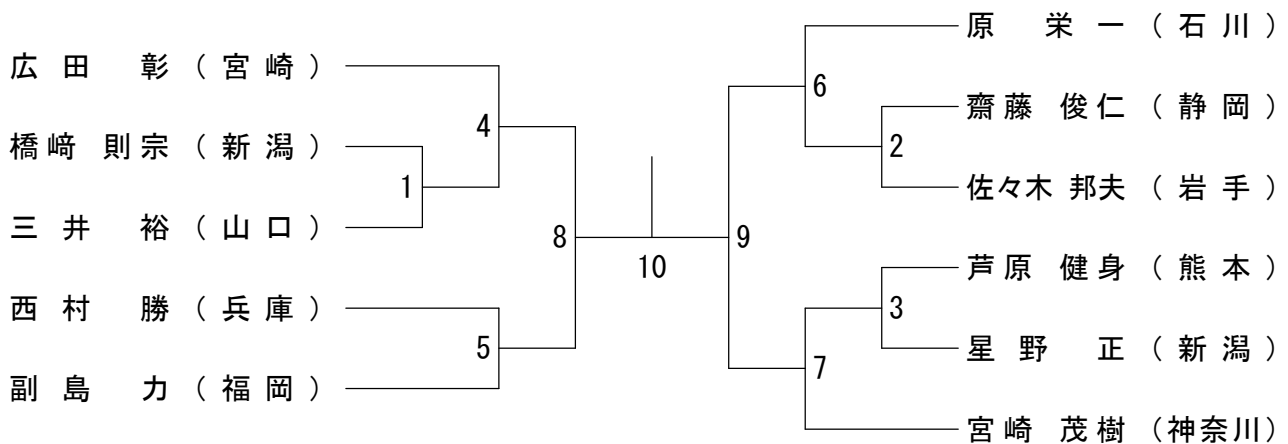

男子70歳以上単 (70MS)

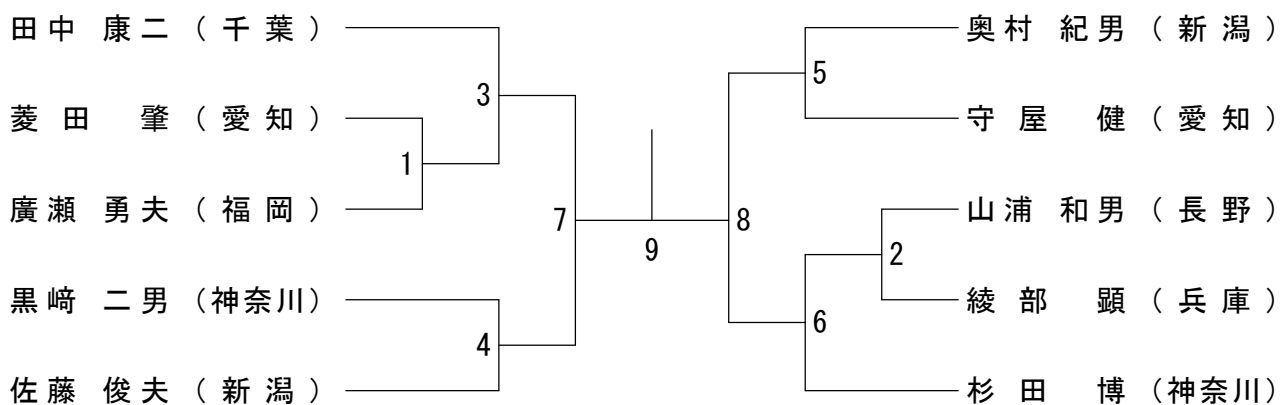

男子30歳以上複 (30MD)

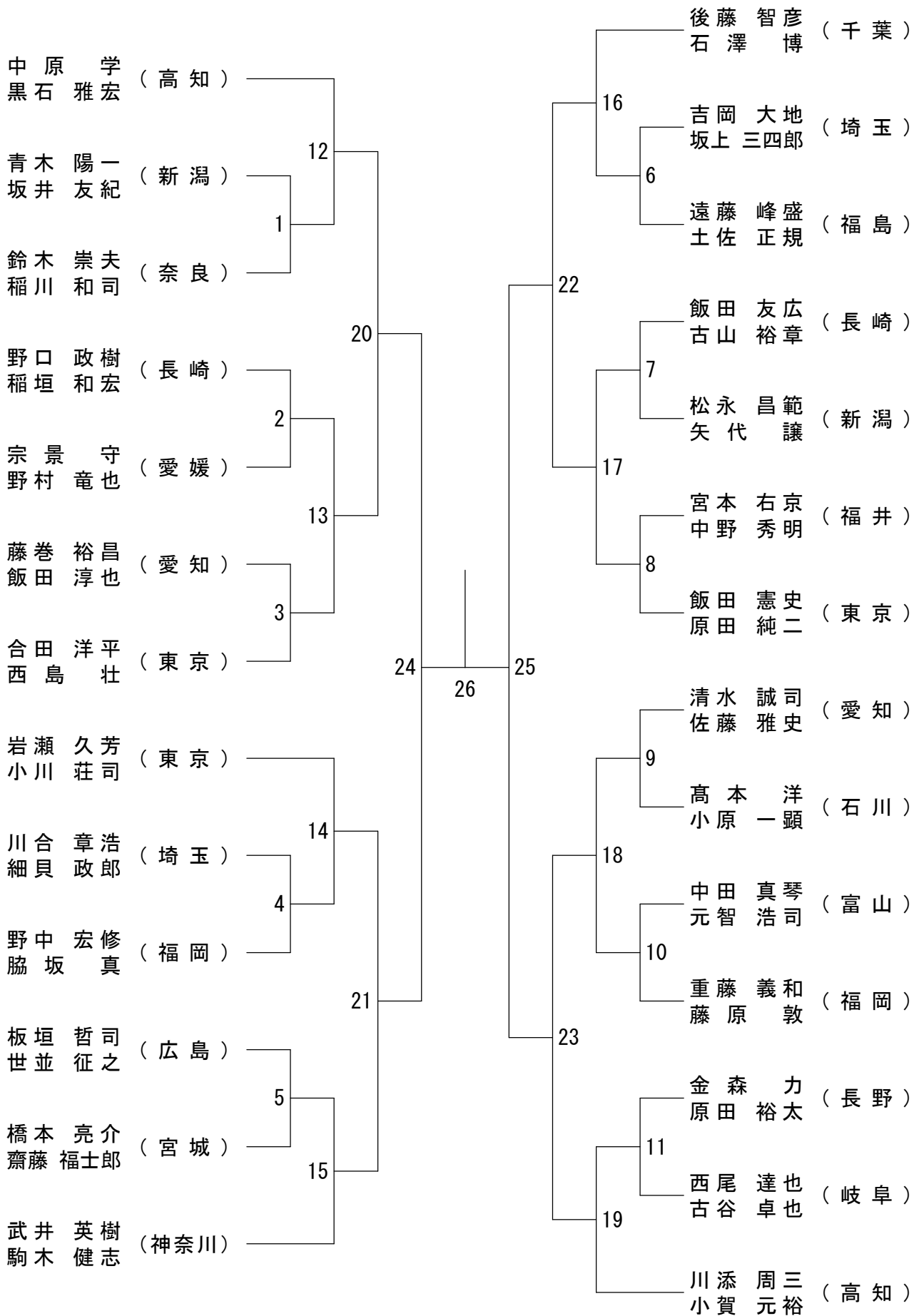

男子40歳以上複 (4 OMD)

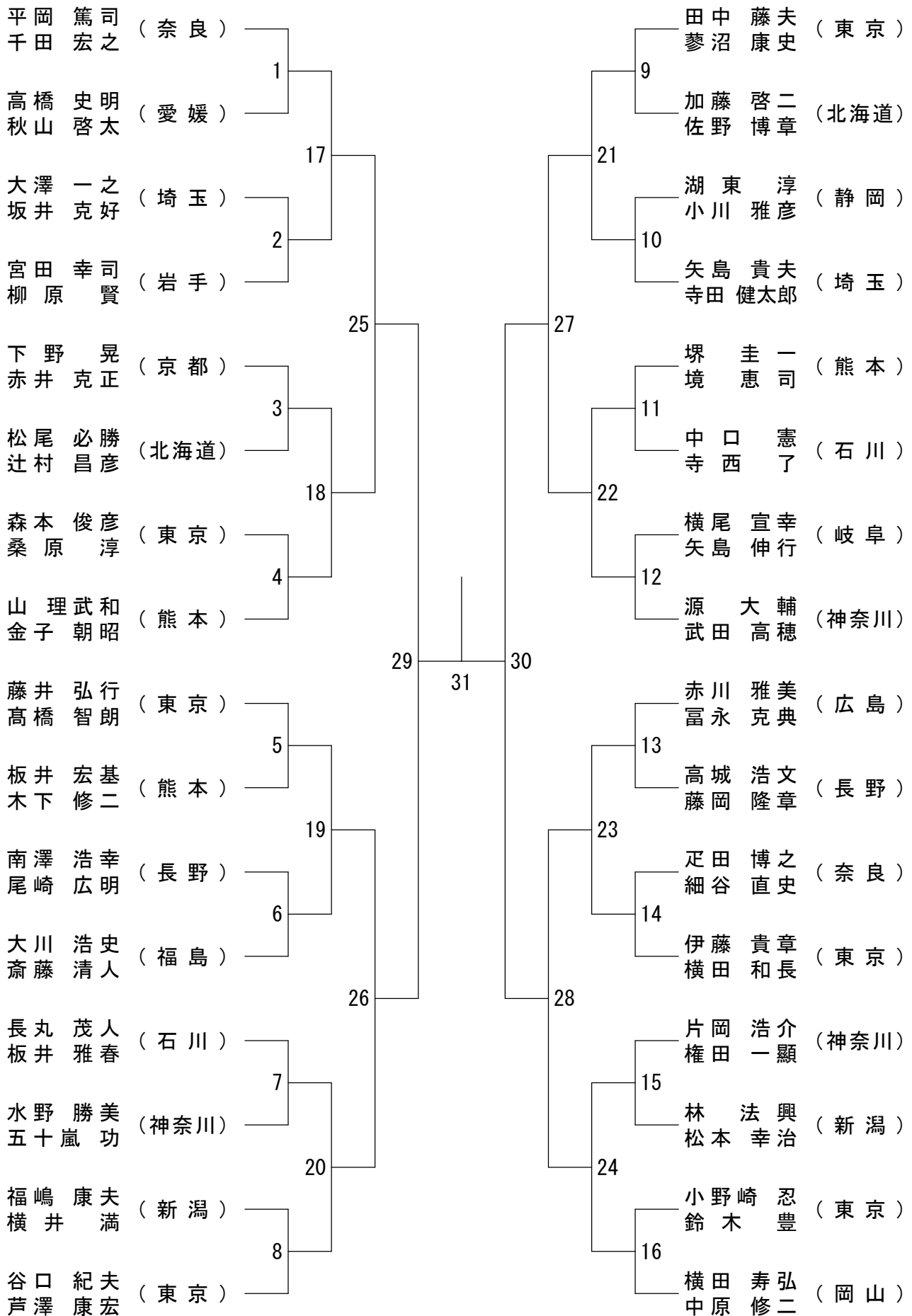

男子50歳以上複 (50MD)

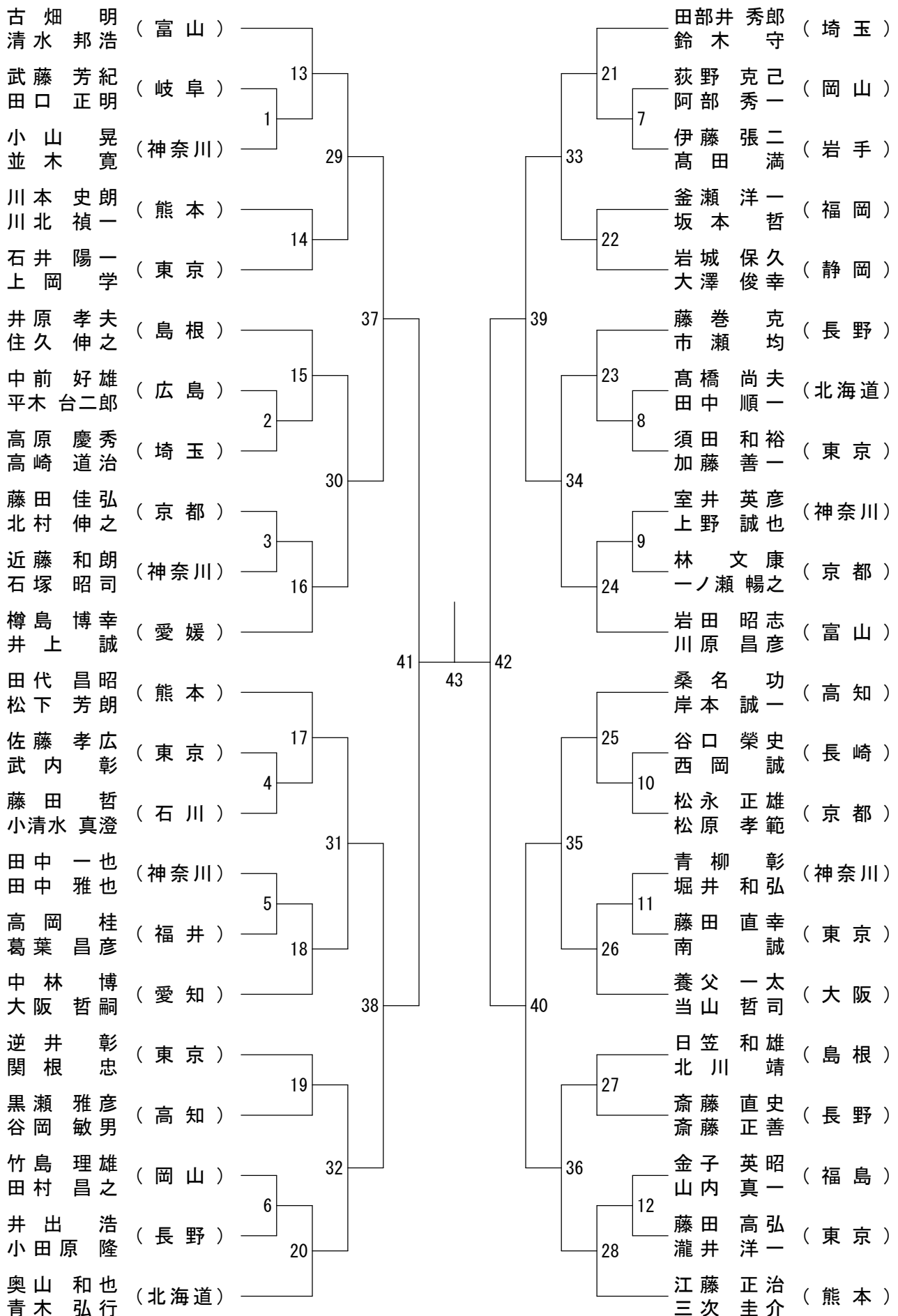

男子60歳以上複 (60MD)

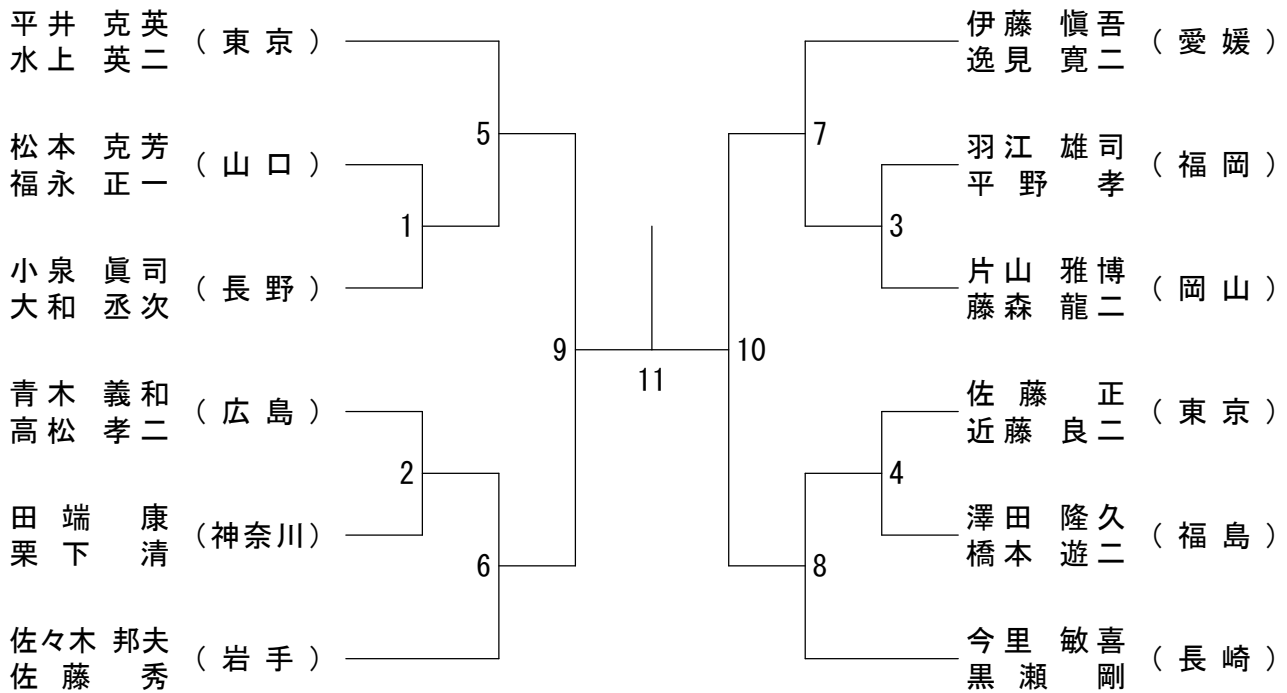

男子65歳以上複 (65MD)

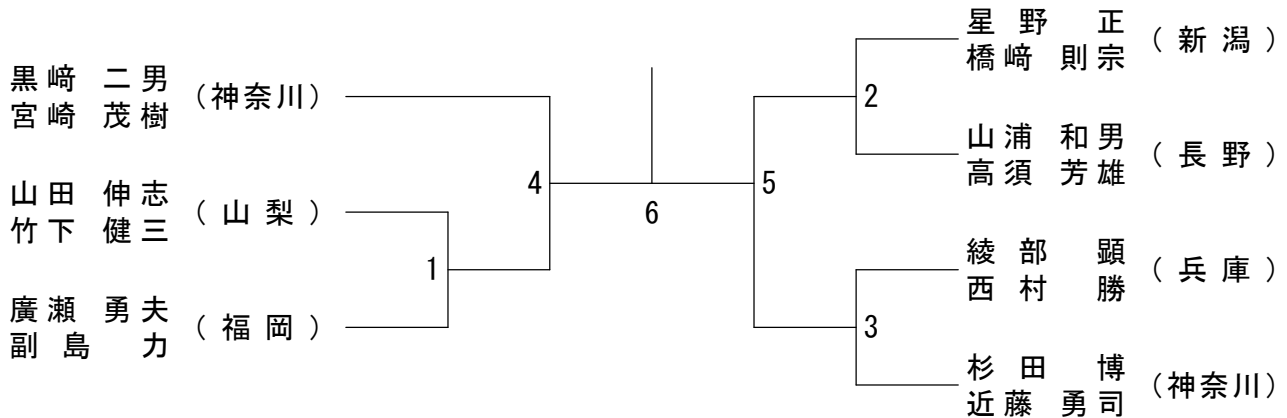

男子70歳以上複 (70MD)

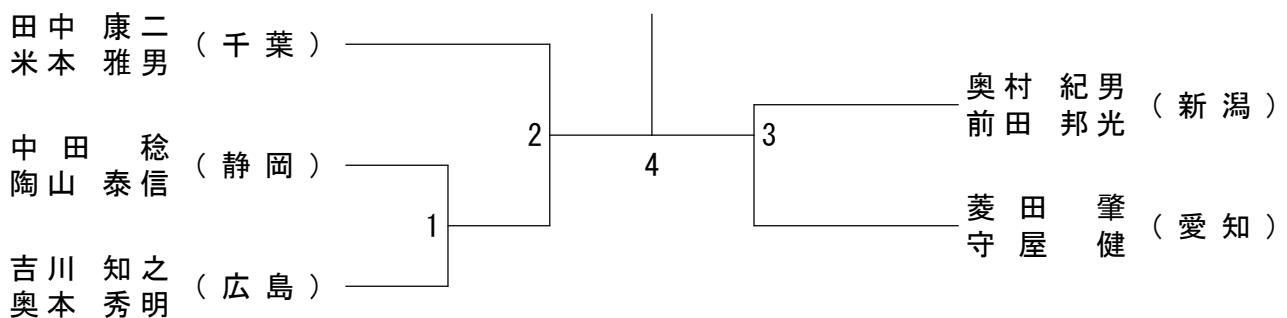

女子30歳以上単 (3 OWS)

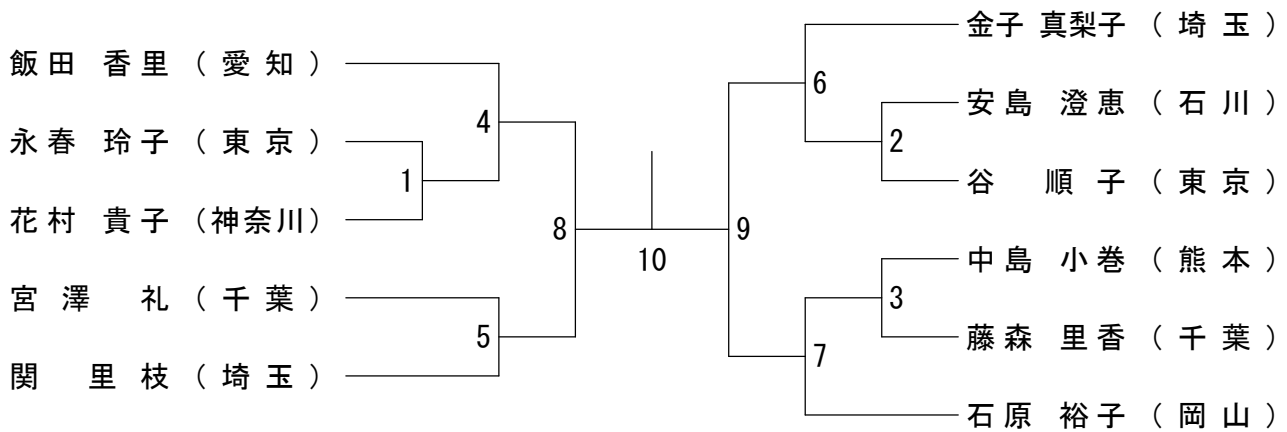

女子40歳以上単 (4 OWS)

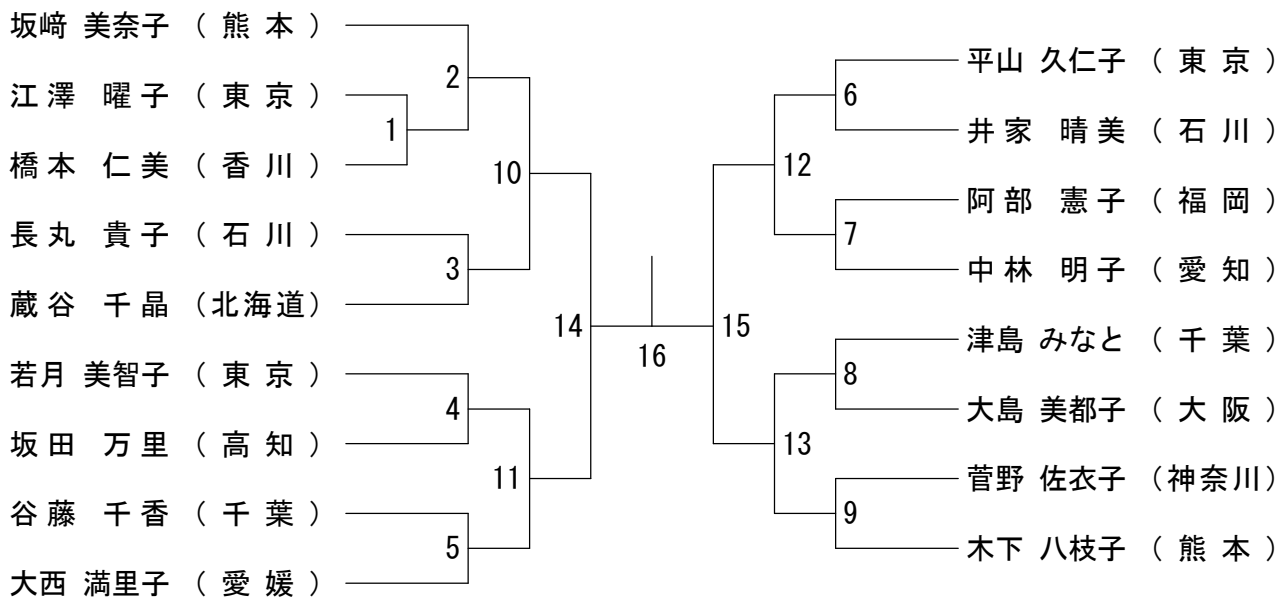

女子50歳以上単 (5 OWS)

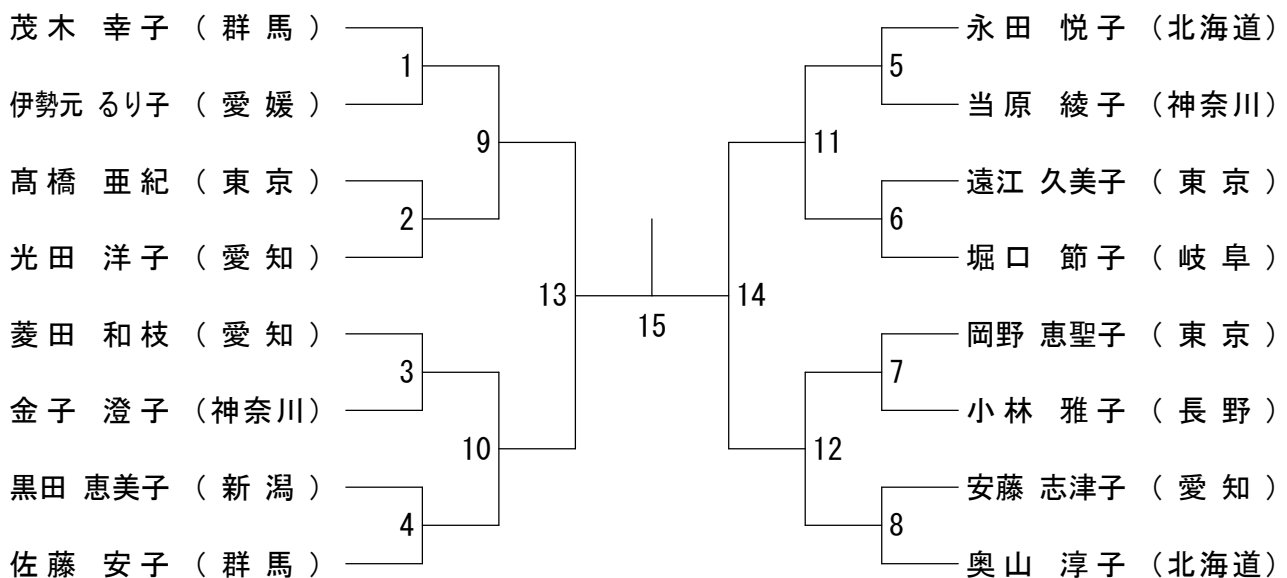

女子30歳以上複 (3 OWD)

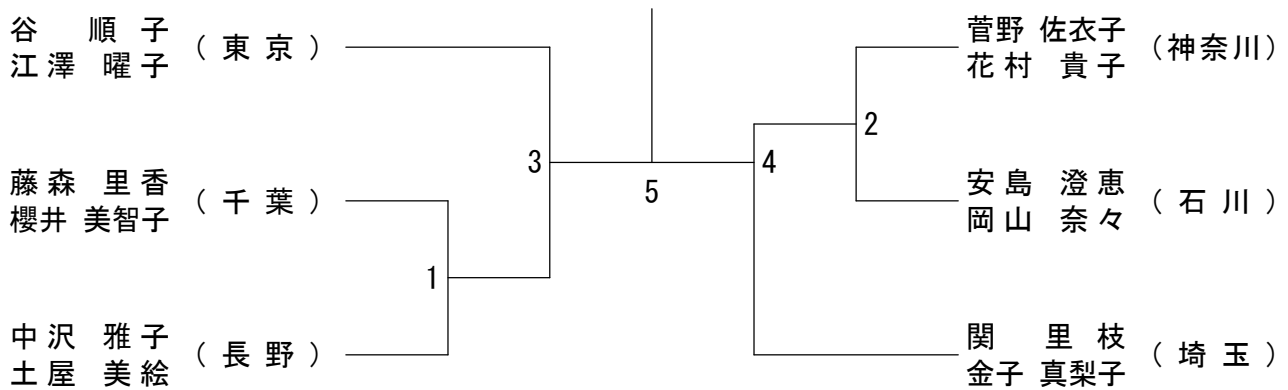

女子40歳以上複 (4 OWD)

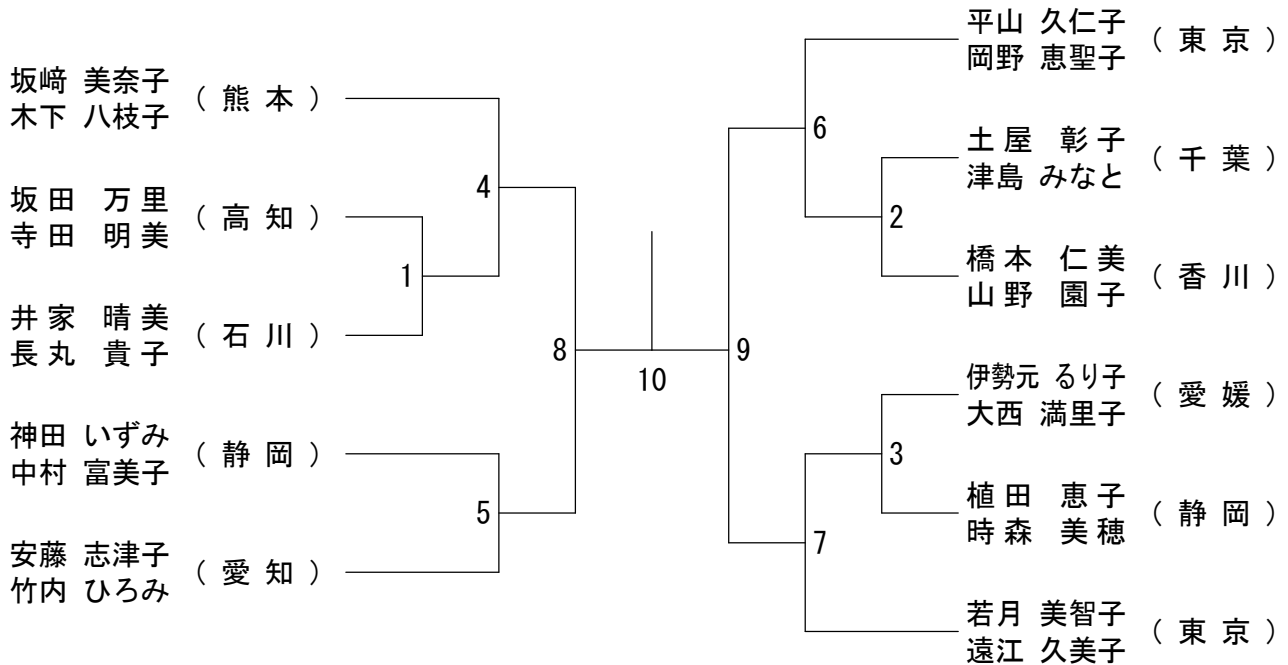

女子50歳以上複 (5 OWD)

